

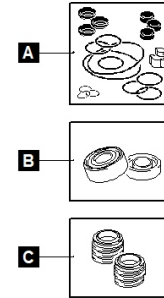

better together

1108.005 - DRBLUEP 200/2/G50V A1CM5 NGTGB51U23N00NN

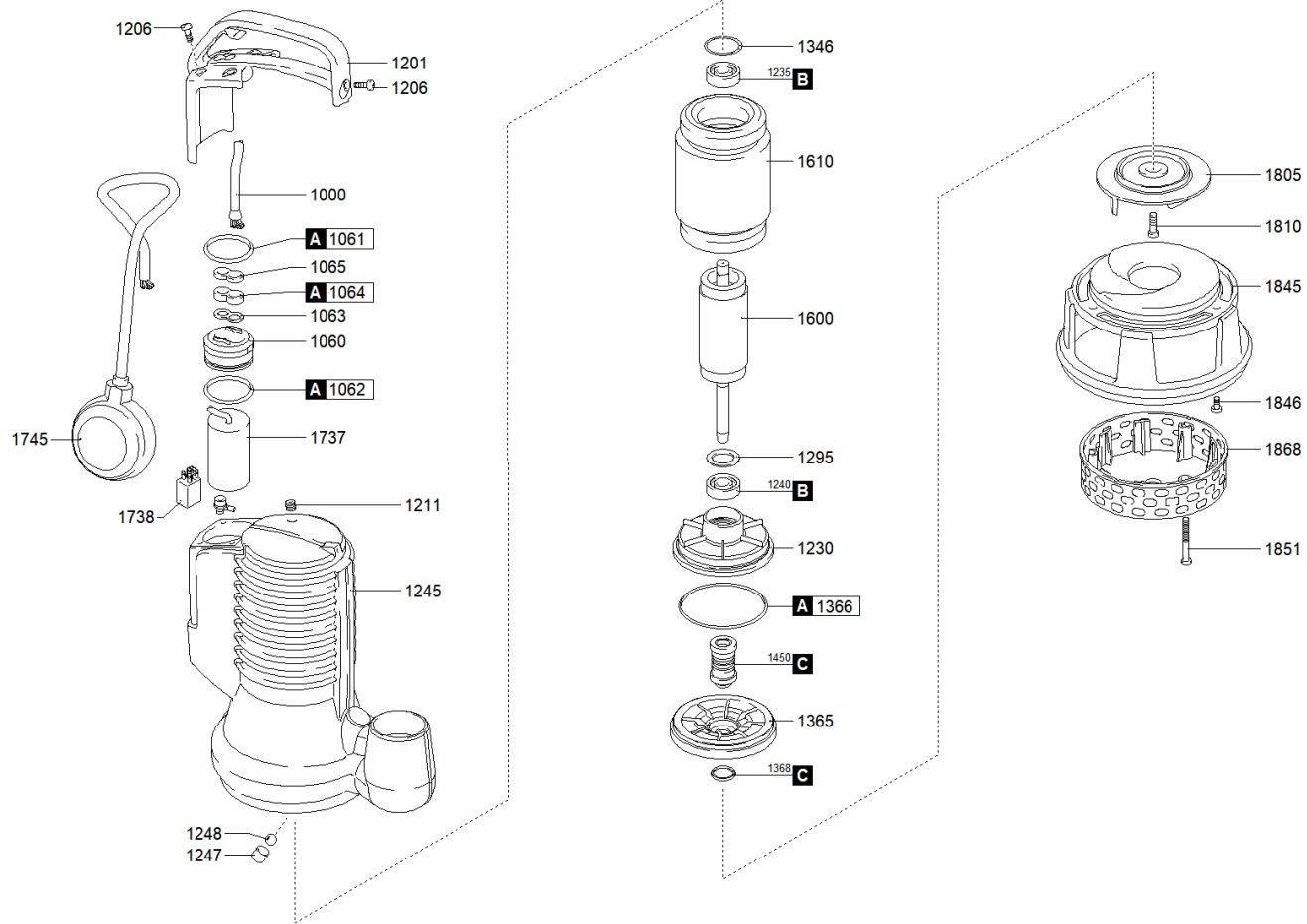



better together



1108.005 - DRBLUEP 200/2/G50V A1CM5 NGTGB51U23N00NN

		Code		New Code		Description	Q.ty
A		601008001		9050.001		GASKETS KIT	1
C		602008031		9050.105		MECHANICAL SEALS KIT	1
B		604008321		9050.168		BEARINGS KIT	1
1000		250102304010200000		2501NN00004		CAVO POTENZA	1
1060		239768026156		2397PL00001		HOLDER [CABLE GLAND]	1
1061		271770412835300000		2717GM00061		UPPER GASKET - HOLDER [CABLE GLAND]	1
1062		271770040952620000		2717GM00058		LOWER GASKET - HOLDER [CABLE GLAND]	1
1063		235467024279		2354PL00001		CABLE STOP	1
1064		235678024236		2356GM00032		RUBBER GASKET	1
1065		235467024241		2354PL00006		CABLE GLAND	1
1201		235361024325		2353PL00002		CABLE GLAND HANDLE	1
1206		270830510149200000		2708XX00087		SCREW [CABLE GLAND HANDLE >> COVER]	5
1211		270139510104000000		2701XX00003		CAP [TIGHTNESS TEST]	1
1230		230556323606		2305AL00003		LOWER BEARING HOLDER	1
1235		2729062030200000		2729NN00008		UPPER BEARING	1
1240		2729063030200000		2729NN00013		LOWER BEARING	1
1245		231016324329		2310GG00010		MOTOR CASE	1
1247		2307605724327		2307PL00002		BUSH [BREATHER]	1
1248		273077224326		2730GM00001		BALL [BREATHER]	1
1295		270220170241500000		2702AG00001		UPPER DISTANCE RING [LOWER BEARING]	1
1346		27542039100000		2754AG00003		WAVE SPRING	1
1365		2391120021023608		2391GG00002		MECHANICAL SEAL FLANGE	1
1366		271770107035000000		2717GM00003		GASKET [LOWER BEARING HOLDER >> MECHANICAL SEAL FLANGE]	1
1368		237970130190600000		2379GM00019		V-RING [MECHANICAL SEAL FLANGE]	1
1450		230005040150000000		2300NN00030		MECHANICAL SEAL	1
1600		230233612023936		2302NN00129		SHAFT WITH ROTOR	1
1610		231101201001000000		2311NN00039		WOUND STATOR	1
1737		2517028100000		2517NN00010		CAPACITOR	1
1745		254500405300000		2545NN00007		FLOAT SWITCH	1
1805		21411001000623948		2141GG00174		IMPELLER	1
1810		270830610203200000		2708XX00103		LOCKING IMPELLER	1
1845		2145113023902		2145GG00006		BASE	1
1846		270830610123200000		2708XX00097		SCREW [BASE >> MOTOR CASE]	3
1851		270830510459200000		2708XX00092		SCREW [STRAINER >> SUCTION FLANGE]	3
1868		216560023484		2165XX00003		CLOSED STRAINER	1

